



# ***PATIENT'S GUIDE for Epilepsy***

**November 2021**

This Patient's Guide is a supplement to the physician's manuals. It is not intended to substitute for advice from your doctor. For a complete discussion of indications for use, contraindications, precautions, warnings, and potential side effects, talk to your doctor.



Your doctor is your first source for health-related questions and information. LivaNova cannot provide healthcare advice or services.

Your doctor's phone number: \_\_\_\_\_

© Copyright 2005 - 2021 LivaNova USA, Inc., Houston, Texas  
All rights reserved.

All trademarks and trade names are the property of LivaNova or the property of LivaNova's consolidated subsidiaries and are protected under applicable intellectual property laws. Solely for convenience, LivaNova's trademarks and trade names may appear without the ® or TM symbols, but such references are not intended to indicate in any way that LivaNova will not assert, to the fullest extent under applicable law, LivaNova's rights to these trademarks and trade names. Prior permission from LivaNova is required for the use or reproduction of such intellectual property rights

The year of authorization to affix the CE mark: 2002

# Table of Contents

<b>1</b>	<b>INTRODUCTION TO VNS THERAPY®</b> .....	<b>4</b>
1.1	Implantable Parts of the VNS Therapy System .....	4
1.2	Nonimplantable Parts of the VNS Therapy System .....	5
<b>2</b>	<b>WHO USES VNS THERAPY?</b> .....	<b>6</b>
2.1	Indications for Use .....	6
2.2	Contraindications .....	6
<b>3</b>	<b>BENEFITS OF VNS THERAPY</b> .....	<b>7</b>
3.1	Reduced Seizure Rate .....	7
3.2	Other Benefits .....	7
3.3	Gradual Improvement .....	7
3.4	Not a Cure for Epilepsy .....	7
<b>4</b>	<b>WARNINGS AND PRECAUTIONS</b> .....	<b>8</b>
4.1	Warnings .....	8
4.1.1.	General .....	8
4.1.2.	Magnetic Resonance Imaging (MRI) Warnings .....	9
4.2	Precautions .....	9
4.2.1.	All Generator Models .....	9
4.2.2.	Model 106 and 1000/1000-D Only .....	9
4.2.3.	Model 1000/1000-D Only .....	10
<b>5</b>	<b>HAZARDS</b> .....	<b>11</b>
5.1	Environmental Hazards .....	11
5.2	Medical Hazards .....	11
5.3	Interference with Other Devices .....	12
<b>6</b>	<b>IMPLANT SURGERY</b> .....	<b>13</b>
6.1	Placement of the Generator and Lead .....	13
6.2	Surgery (Operation) .....	13
<b>7</b>	<b>FOLLOW UP AFTER SURGERY</b> .....	<b>14</b>
7.1	Antiepileptic Medications (Drugs for Seizures) .....	14
7.2	Programming Your Generator .....	14
7.2.1.	Normal Mode .....	14
7.2.2.	Magnet Mode .....	15
7.2.3.	AutoStim Mode (Model 106 and 1000/1000-D Generators Only) .....	15
7.3	After Treatment Begins .....	15
7.3.1.	Common Side Effects .....	15
7.3.2.	Medical Tests and Other Devices .....	16
<b>8</b>	<b>THE VNS THERAPY MAGNETS</b> .....	<b>17</b>
8.1	Magnet Cautions .....	17
8.2	Magnet Precautions .....	17
8.3	How to Handle the VNS Therapy Magnets .....	17
8.4	Magnet Accessories .....	18
8.5	How the Magnets Work .....	18
8.6	How to Use the Magnet .....	18

8.6.1.	Start Stimulation .....	19
8.6.2.	Stop Stimulation .....	20
8.6.3.	Check the Generator Battery .....	20
8.7	How to Replace the VNS Therapy Magnets .....	20
<b>9</b>	<b>DEVICE COMPLICATIONS .....</b>	<b>21</b>
9.1	Surgery .....	21
9.2	Generator Malfunction (Device Not Working Right) .....	21
9.3	Battery Depletion (Running Out) .....	21
9.4	Manipulation of the Generator and Lead .....	22
<b>10</b>	<b>PATIENT REGISTRATION AND SAFETY LISTING .....</b>	<b>23</b>
<b>11</b>	<b>FREQUENTLY ASKED QUESTIONS .....</b>	<b>24</b>
<b>12</b>	<b>GLOSSARY .....</b>	<b>28</b>
<b>13</b>	<b>CONTACT INFORMATION .....</b>	<b>30</b>
<b>14</b>	<b>CLINICAL STUDY PARTICIPANTS .....</b>	<b>31</b>
14.1	Side Effects .....	31
14.1.1.	Common Side Effects .....	31
14.1.2.	Surgical Complications .....	33
14.1.3.	Surgical Scars .....	33
14.2	Sudden Unexpected Death in Epilepsy (SUDEP) .....	34

## List of Figures

FIGURE 1	IMPLANTABLE PARTS OF THE VNS THERAPY SYSTEM .....	4
FIGURE 2	NONIMPLANTABLE PARTS .....	5
FIGURE 3	IMPLANT LOCATION .....	13
FIGURE 4	MAGNET ACCESSORIES .....	18
FIGURE 5	START STIMULATION .....	19
FIGURE 6	STOP STIMULATION .....	20

# 1 Introduction to VNS Therapy®

Many people have epilepsy. Through the years, doctors and scientists have learned much about seizures. They have developed drugs and other treatments. Despite these efforts, some people still have seizures. Your doctor has proposed the VNS Therapy System for you to reduce the frequency and duration of your seizures because drugs either have failed to control them adequately or have caused bad side effects.

The VNS Therapy System sends a mild electrical impulse to a nerve that goes to the brain. This nerve is called the vagus nerve. The treatment is vagus nerve stimulation (VNS) Therapy (VNS Therapy®).

With the AspireSR® (Model 106), SenTiva® (Model 1000) and SenTiva Duo™ (Model 1000-D) generator, VNS Therapy also provides an Automatic Stimulation Mode that delivers stimulation at the onset of a seizure. This may stop the seizure, decrease the severity of the seizure, or improve the recovery time after the seizure.

**i** **Note:** See the "Glossary" on page 28 for terms and definitions used in this guide.

## 1.1 Implantable Parts of the VNS Therapy System

**Figure 1. Implantable Parts of the VNS Therapy System**

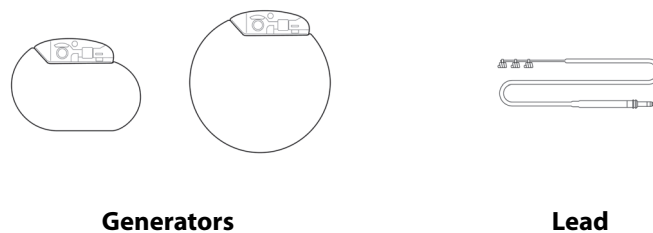

### Generator

The main implantable part is the VNS Therapy generator, sometimes called a stimulator. The generator is computer controlled and battery powered. It sends signals through the electrodes of the lead to the brain through the left vagus nerve in the neck. These signals help reduce the rate and duration of seizures.

The generators have many settings for normal and magnet stimulation. Some models have settings related to automatic stimulation. Your doctor will choose the settings for your generator. The stimulation settings can be changed at any time with the programming system. Most of the time, changing the settings is a painless procedure, takes only a few minutes, and can be done in your doctor's office.

**i** **Note:** See "Programming Your Generator" on page 14.

### Lead

The lead connects the generator to the vagus nerve.

## 1.2 Nonimplantable Parts of the VNS Therapy System

**Figure 2. Nonimplantable Parts**

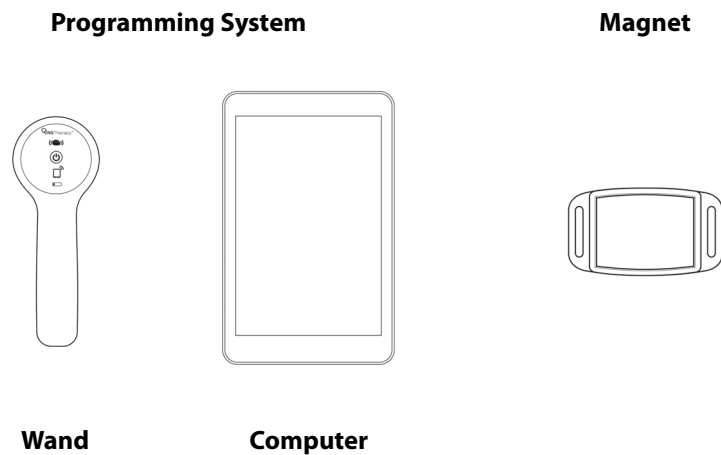

### **Programming System**

The programming system includes the Programming Wand and Programming Computer with pre-installed software.

### **Magnet**

Your doctor provides a magnet for you to stop or to activate stimulation when it is needed.

**i** **Note:** See “The VNS Therapy Magnets” on page 17.

## 2 Who Uses VNS Therapy?

Doctors prescribe VNS Therapy for people with certain types of seizures and medical backgrounds. It *is not right* for everyone who has epilepsy. Your doctor will decide if your seizures are the correct type to treat with VNS Therapy. Your doctor will also decide if you have any other medical conditions that might be affected by VNS Therapy.

### 2.1 Indications for Use

The VNS Therapy System is indicated for use as an adjunctive therapy in reducing the frequency of seizures in patients whose epilepsy disorder is dominated by partial seizures (with or without secondary generalization) or generalized seizures that are refractory to seizure medications.

If you have the AspireSR (Seizure Response) Model 106, SenTiva Model 1000 or SenTiva Duo Model 1000-D device, it has a feature called the Automatic Stimulation Mode. This feature is for patients who experience seizures that are associated with an increase in heart rate. The feature can also be turned off by your physician, allowing the device to operate the same way as other VNS Therapy System models.

### 2.2 Contraindications

VNS Therapy should not be used (is contraindicated) in the following situations or procedures:

- **Left vagotomy** — The VNS Therapy System should not be used (is contraindicated) in people who have had the left vagus nerve cut to treat another disorder (a left vagotomy).
- **Diathermy** — Inform anyone treating you that you CANNOT have any short-wave diathermy, microwave diathermy, or therapeutic ultrasound diathermy (hereafter referred to as “diathermy”) anywhere on your body because you have an implanted VNS Therapy System (sometimes referred to as a “Vagus Nerve Stimulator” or “Vagus Nerve Stimulation”). Injury or damage can occur during diathermy treatment whether your VNS Therapy System is turned “ON” or “OFF.”



**Note:** Diagnostic ultrasound is not included in this contraindication.

Diathermy is a treatment to promote healing or relieve pain. It is provided by special medical equipment in a doctor's office, dentist's office, or other healthcare setting.

Energy from diathermy therapy may cause heating of the VNS Therapy System. The heating of the VNS Therapy System resulting from diathermy can cause temporary or permanent nerve, tissue, or blood vessel damage. This damage may result in pain or discomfort, loss of vocal cord function, or possible death if blood vessels are damaged.

Diathermy may also damage parts of your VNS Therapy System. This damage can result in loss of therapy from your VNS Therapy System. More surgery may be required to remove or replace parts of your implanted device.

## 3 Benefits of VNS Therapy

### 3.1 Reduced Seizure Rate

Successful VNS Therapy decreases seizure rate. Some patients have reported a large decrease, others only a slight decrease, and still others no decrease. On the whole, the patients involved in the VNS Therapy clinical trials had a statistically significant (mathematically important) decrease in their seizure rates.

### 3.2 Other Benefits

Many patients and doctors have seen other changes as well. For some patients, VNS Therapy has resulted in:

- Less severe or shorter seizures
- Better recovery after seizures (postictal period)
- Improved feeling of well-being
- Better mood
- Improved alertness, memory, and thinking skills
- Fewer emergency room visits

Doctors have been able to reduce the dose of seizure drugs for some patients.

### 3.3 Gradual Improvement

The benefits of VNS Therapy are not always seen *right away*. In fact, seizure activity may improve *slowly* over the first 2 years of treatment. Long-term results from clinical studies suggest that the effects of VNS Therapy *are* significant and last over time.

### 3.4 Not a Cure for Epilepsy

VNS Therapy is not a cure for epilepsy and it does not work for everyone.

Doctors who tested the VNS Therapy System cite the “Rule of Thirds” about long-term results. In the long-term VNS Therapy studies, one-third of the patients had a *dramatic* improvement in seizure control, one-third had a *good* improvement, and one-third had *little or no* improvement. At present, doctors have no way to predict which patients will respond to VNS Therapy.



## 4 Warnings and Precautions

As with all types of treatment for epilepsy, VNS Therapy carries some risks. Talk to your physician about the following warnings, precautions, side effects, and hazards. Ask about other risks not covered in this manual that you should know about as well as any other issues that might be appropriate to discuss, such as status epilepticus and sudden unexpected death in epilepsy.

### 4.1 Warnings

#### 4.1.1 General

- **Avoid excessive vagus nerve stimulation** — Excessive stimulation of the vagus nerve can be produced by frequent magnet activation or more than 4 hours of continuous stimulation due to repeated magnet activations.
- **Unapproved uses** — The safety and efficacy of the VNS Therapy System have not been established for uses outside its approved indications for use. The safety and efficacy of VNS Therapy *have not been shown* for people with these conditions:
  - ◆ History of previous therapeutic brain surgery or brain injury
  - ◆ History of dysautonomias
  - ◆ History of lung diseases or disorders, including shortness of breath and asthma
  - ◆ History of ulcers (gastric, duodenal, or other)
  - ◆ History of fainting (vasovagal syncope)
  - ◆ Irregular heartbeats (Heart arrhythmias) or other heart abnormalities
  - ◆ Only one vagus nerve
  - ◆ Other concurrent forms of brain stimulation
  - ◆ Pre-existing hoarseness
  - ◆ Progressive neurological diseases other than epilepsy
- **Swallowing difficulties** — Difficulty swallowing may occur with active stimulation, and aspiration may result from the increased swallowing difficulties. Use of the magnet to temporarily stop stimulation while eating may mitigate the risk of aspiration.
- **Shortness of breath** — Shortness of breath may occur with active VNS Therapy, especially if you have chronic obstructive pulmonary disease or asthma.
- **Obstructive sleep apnea** — Use of the VNS Therapy device can cause or worsen pre-existing obstructive sleep apnea (episodes where breathing stops for short periods of time while sleeping). You should see your physician if you show any signs or symptoms of obstructive sleep apnea or worsening obstructive sleep apnea.
- **Device malfunction** — Device malfunction could cause painful stimulation or direct current stimulation. Either event could cause nerve damage and other associated problems.
- **Device removal** — Removal of the VNS Therapy System requires an additional surgical procedure. When a device is removed, the surgeon may leave part of the lead behind. This may pose certain risks. See “Medical Hazards” on page 11.

- **Device manipulation** — Do not manipulate the generator and lead through the skin, as this may damage or disconnect the lead from the generator and/or possibly cause damage to the vagus nerve.
- **Device trauma** — Blunt trauma to the neck and/or any area of the body beneath which the lead is implanted could possibly cause damage to the lead.
- **The VNS Therapy System does not stop all seizures** — Continue to avoid activities that can be hazardous to you and others, such as driving and swimming alone.

#### 4.1.2 Magnetic Resonance Imaging (MRI) Warnings

- **Before having any MRI performed** — **Call your doctor, so your VNS Therapy System can be discussed with the MRI personnel.** In many cases, an MRI can be performed safely under certain conditions. However, for a few other cases, surgery may be required to remove the VNS Therapy System prior to an MRI. *Before* undergoing an MRI scan with your VNS Therapy System, the VNS system diagnostic information will be collected and the current turned off. The current will be turned on again after the scan is completed. Your doctor has access to detailed MRI-related information in the physician's manual.
- **MR Unsafe**  — The VNS Therapy patient magnet is **MR Unsafe**. *Do not* carry the patient magnet into the MR scanner room. The magnet could become a dangerous flying object if attracted by the strong magnetic field of the MRI scanner.
- **Pain or other sensation during MRI scan** — If, during an MRI scan, you have any pain, discomfort, heating, or other unusual sensations, notify the MRI operator, so the MR procedure can be stopped.
- **Cardiac Arrhythmia (Model 106 or 1000/1000-D only)** — If you have a cardiac arrhythmia, the Automatic Stimulation feature of the Model 106 is not suitable for you. This includes heart conditions or treatments that do not allow necessary changes in your heart rate, such as atrial fibrillation, pacemaker dependency, implantable defibrillator, or cardiac medications such as beta blockers.
- **Questions?** — **Call your doctor** if you have questions about having an MRI scan.

## 4.2 Precautions

### 4.2.1 All Generator Models

- **Use during pregnancy**— The safety and effectiveness of the VNS Therapy System have not been established for use during pregnancy.
- **Laryngeal irritation may result from stimulation**— Patients who smoke may have an increased risk of laryngeal (commonly called the “voice box”) irritation.

### 4.2.2 Model 106 and 1000/1000-D Only

- **Use during exercise** — Exercise or physical activity may trigger Automatic Stimulation if the feature is ON due to heart rate changes detected by the device.
- **Heart Rate Changes Not Associated with Seizures** — Situations, including but not limited to exercise or physical activity, that cause rapid increases in heart rate may trigger Automatic Stimulation if the feature is ON. If this is a concern, talk to your doctor about

ways to stop stimulation during these situations. This could include using your magnet or having your doctor turn the AutoStim feature OFF.

- **Battery Drain** — If your doctor has turned on the AutoStim feature, there will be a greater impact on battery life than if the feature is turned off, which may require more frequent generator replacements.
- **AutoStim follow-up visits** — Use of the AutoStim feature will reduce battery life. Once the AutoStim feature has been activated, your doctor will work with you to determine a treatment plan to get to the most benefit.

#### 4.2.3 Model 1000/1000-D Only

- **Time-based Features** — Optional time-based features (e.g., Day-Night Programming, Scheduled Programming) do not automatically adjust for Day Light Savings Time or time zone changes. If you are using one of these features, you will need to go back to your doctor for reprogramming of the generator for any time changes.

## 5 Hazards

### 5.1 Environmental Hazards

Being close to certain types of equipment can affect the generator. Move away from or avoid equipment such as transmitting antennas.

- **Pacemaker Warning signs** — Talk to your doctor before going into places with Pacemaker Warning signs.
- **Small appliances** — Properly operating microwave ovens and other small electrical appliances, such as toasters, hair dryers, and electric shavers, *should not affect* the generator.
- **Cellular phones** — Cellular phones can affect some implanted cardiac defibrillators and pacemakers, but tests to date show that they *do not affect* the generator.
- **Transmitting devices** — Properly operating electrical ignition systems and power transmission lines *should not affect* the generator. Sources with high energy levels, such as transmitting antennas, *may interfere* with the device. Move at least 1.8 meters (6 feet) away from any equipment that interferes with your device.
- **Antitheft devices, airport security systems, and other metal detectors** — Antitheft devices and metal detectors should not affect the generator or be affected by it. As a precaution, however, move through them at a steady pace; do not linger in the area and stay at least 40 centimeters (16 inches) away from such equipment.
- **Electronic Article Surveillance (EAS) System tag deactivators** — The tag deactivators found in many retail stores can interfere with VNS Therapy when it is used near the generator. It can cause accidental activations or stop pulses. Stay at least 60 centimeters (2 feet) away from tag deactivators to avoid potential interference.
- **Devices with strong electromagnetic fields** — Electrical or electromechanical devices with a strong static or pulsing magnetic field can cause the generator to start suddenly. Such devices may include strong magnets, tablet computers and their covers, hair clippers, vibrators, antitheft tag deactivators, and loudspeakers. Keep this type of equipment at least 20 centimeters (8 inches) away from your chest. If your generator stops while you are in a strong electromagnetic field, move away from the source so the device may return to regular operation.

### 5.2 Medical Hazards

Medical equipment, procedures, and surgery using certain electrical instruments can affect the VNS Therapy System's operation and sometimes damage the generator or lead.



Make sure that medical personnel know you have a device implanted in your chest.



Always call your doctor *before* you have any medical tests that may affect, or be affected by, the VNS Therapy System as described in this section. Precautions may be needed.

- **Routine diagnostic procedures** — Most routine diagnostic procedures, such as diagnostic ultrasound and radiography (x-rays), *should not affect* the VNS Therapy System.

- **Mammography** — Because the generator is in your chest, you may need to be specially positioned for a mammogram. Otherwise, the device may be seen as a shadow on the mammogram. It could make a lesion or lump in that area hard or even impossible to detect. Make sure that your doctor and the mammography technician are aware of the implanted device.
- **Radiation treatment** — Treatment with radiation, cobalt machines, and linear accelerators *may damage* the generator. No testing has been done to date. The effect of radiation on the device is not known. Talk with your doctor if you plan to have radiation treatment.
- **Other procedures** — External cardiac defibrillation and other procedures for heart problems, as well as extracorporeal shockwave lithotripsy, diathermy, and electrocautery, *may damage* the generator. If you had any of these procedures and your doctor did not know about it, have the generator checked. While *diagnostic* ultrasound *should not affect* the VNS Therapy System, *therapeutic* ultrasound therapy *could damage* the generator or inadvertently harm you.

### 5.3 Interference with Other Devices

While the generator is stimulating or being set or tested, it may briefly interfere with nearby equipment. If this happens, move at least 1.8 meters (6 feet) away from such equipment.

- **Radios and hearing aids** — The generator can interfere with devices that operate in the 30 kHz to 100 kHz range. Hearing aids and transistor radios operate in this range. In theory, the generator could affect them, but no effects have yet been reported. No detailed testing has been done, so the effects are unknown.
- **Implanted devices** — The generator may affect other implanted medical devices, such as cardiac pacemakers and implantable defibrillators. Possible effects include sensing problems. These could lead to inappropriate responses from the generator.
- **Credit cards and computer disks** — The VNS Therapy magnets are very strong. They *can damage* televisions, computer disks, credit cards, and other items that are affected by strong magnetic fields. Keep your magnet at least 25 centimeters (10 inches) away from any of these items. **Do not carry or store the magnets near them.**

## 6 Implant Surgery

VNS Therapy requires surgical placement of the generator and lead by a surgeon. At office visits, your doctor checks the settings and changes them as needed.

### 6.1 Placement of the Generator and Lead

The generator is placed under the skin of the upper chest. The lead is surgically attached to the vagus nerve on the left side of the neck and runs under the skin to connect to the generator. See Figure 3.

**Figure 3. Implant Location**

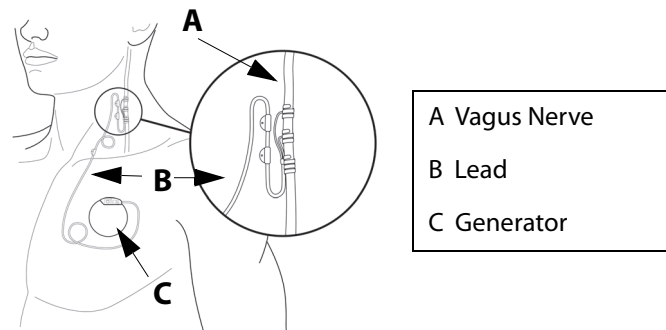

### 6.2 Surgery (Operation)

The implant surgery lasts from about 1 to 2 hours and typically involves general anesthesia, though local anesthesia is sometimes used. You may stay in the hospital overnight.

The surgeon makes a small incision on the left side of the neck and a second incision below the collarbone in the chest or armpit. The lead is passed under the skin between the two incisions. The surgeon attaches the lead to the left vagus nerve in the neck and then plugs the other end of the lead into the generator. The generator is placed in the “pocket” created at the site of the incision below the collarbone. Finally, the surgeon closes the incisions (see Figure 4). The operation can be reversed if you and your doctor ever decide to have the VNS Therapy System removed. Removal of the generator and/or lead requires another surgical procedure.



Sometimes when a surgeon removes a VNS Therapy System, the surgeon will decide to leave a portion of the lead behind in order not to risk damaging the vagus nerve. This may pose certain risks (see “Medical Hazards” on page 11).

## 7 Follow Up After Surgery

The generator is usually turned on 2 weeks after it is implanted. Your doctor will program the generator to the proper settings for you. At that office visit and at subsequent visits, your doctor will check the VNS Therapy System. Your doctor will make sure that it is working well and that the treatment is comfortable for you.



LivaNova recommends that you see your doctor **at least once every 6 months. Your doctor will check the VNS Therapy System for safe and effective operation.**

You will be given an Implant and Warranty Registration form, which has information about your generator and lead.

You will also receive a Patient Implant Card, which has details about your generator and lead, your physician name and number, and other information needed in case of a device-related emergency.



Carry the Patient Implant Card at all times.

Consider registering with an emergency service such as MedicAlert® Foundation ([www.medicalert.org](http://www.medicalert.org)) so information about the VNS Therapy System will be available to hospital and emergency response personnel when needed. If you have questions about the MedicAlert Foundation, discuss it with your doctor.

### 7.1 Antiepileptic Medications (Drugs for Seizures)

You will continue to take your regular antiepileptic medications for epilepsy for at least 3 months after surgery. Your doctor may try to change your drugs after that time. For many patients, the medications will not be changed. Always follow your doctor's instructions about your medications.

### 7.2 Programming Your Generator

The generator has several settings. Your doctor sets the generator to deliver periodic stimulation 24 hours a day. If you have a Model 106 or 1000/1000-D, your doctor may also enable an automatic stimulation feature, which responds to seizures. At the office, your doctor can read and change stimulation settings with the programming system.

Your generator is set for two types (modes) of stimulation: Normal Mode and Magnet Mode. If you have the Model 106 or 1000/1000-D, there is an Automatic Stimulation feature (AutoStim Mode) that can be used together with Normal Mode. Each mode is independent of the other. The settings are *usually (but not always)*, different for the modes. Your doctor chooses and sets the cycle time and the amount of current for each mode. See "Programming Your Generator" on page 14

#### 7.2.1 Normal Mode

**Normal Mode stimulation** has an automatic ON and OFF cycle (e.g., 30 seconds ON and 5 minutes OFF). Your generator operates in this mode most of the time.



**Note:** Tell your doctor at your next visit if you no longer feel the routine stimulation. Your doctor may decide to change your settings.

## 7.2.2 Magnet Mode

**Magnet Mode** gives a single, on-demand stimulation. *On-demand* means that *you* control when it starts by using the magnet. Your doctor may set Magnet Mode stimulation longer than Normal Mode stimulation. The current may be a little higher so that you know when it starts. Magnet Mode can be used to start a single stimulation cycle and to check the battery. The magnet (on-demand) stimulation is in addition to the Normal stimulation and Automatic Stimulation Mode (applies to Model 106 and 1000/1000-D).

If you feel no stimulation when you pass the magnet over the generator, ask your doctor about increasing the magnet stimulation.

**i** **Note:** If Magnet Mode has not helped you in the past, your doctor may have turned the Magnet Mode feature OFF. If it is OFF, you will not be able to use the magnet to start stimulation or to check the battery. **You will always be able to stop any stimulation (to turn your generator OFF) with the magnet.**

## 7.2.3 AutoStim Mode (Model 106 and 1000/1000-D Generators Only)

AutoStim Mode is a feature that can be used together with the Normal Mode. It monitors and detects rapid, relative heart rate increases ( $\geq 20\%$ ) that may be associated with seizures. You may or may not have these types of heart rate increases with your seizures.

Discuss the AutoStim studies with your doctor to determine if this feature is right for you. If your doctor decides to turn this feature on, the stimulation may be set equal to or a little higher than Normal Mode.

**i** **Note:** AutoStim may not be appropriate for everyone, so you and your doctor may decide to turn this feature off. You will always be able to stop Normal, AutoStim, or Magnet Mode stimulation with the magnet.

## 7.3 After Treatment Begins

### 7.3.1 Common Side Effects

**Call your doctor right away** if any of the following occur:

- Your voice is constantly hoarse.
- The stimulation becomes painful or irregular.
- The stimulation causes any choking, trouble with breathing, trouble with swallowing, or change in heart rate.
- You or someone else notices changes in your level of consciousness (e.g., you become constantly drowsy).
- You think that the generator may not be stimulating properly or that the VNS Therapy System battery is depleted (stops stimulating).
- You notice anything new or unusual that you relate to the stimulation.
- The feeling that you usually have during stimulation becomes stronger or weaker.

**i** **Note:** See "Device Complications" on page 21 and "Side Effects" on page 31.

- Your seizure rate, intensity, or duration (or any combination) increases.



## 7.3.2 Medical Tests and Other Devices

**Call your doctor *before* you:**

- have **any medical tests** that might affect, or be affected by, the VNS Therapy System, [e.g., magnetic resonance imaging (MRI) scans].
- have an MRI scan. Because you have a VNS Therapy System, you can have certain types of MRI scans but not others. If you have a MRI scan, it must be done under specific conditions. **Call your doctor before you have an MRI scan.**

 **Note:** See “Magnetic Resonance Imaging (MRI) Warnings” on page 9.

- have **any other medical devices implanted.**

 **Note:** See “Medical Hazards” on page 11.

## 8 The VNS Therapy Magnets

After your operation, your doctor will give you two magnets and accessories. The magnets contain a high-power magnet that is surrounded by a plastic casing in the shape of a watch. With normal use, they should remain powerful for approximately 3 years.

Each person has different results from using the magnet. Some people say that the magnet *stops* all or most seizures, *shortens* them, or *lessens* their intensity or their recovery period. For other people, the magnet has little or no effect. Even if the magnet has little effect for you, keep one with you at all times. You may need to turn OFF the generator.

### 8.1 Magnet Cautions

- **If stimulation hurts**, contact your doctor right away
- **Always carry the magnet with you.** Show your family members or caregivers how to use it.
- **Do not place the magnet over a pacemaker** since it may affect pacemaker function and could change the pacing rate.
- **Do not place the magnet over a defibrillator** (sometimes called ICD) since it could turn the device OFF
- **Avoid over stimulation.** More than 8 hours of constant stimulation (from magnet use) may hurt your left vagus nerve.

### 8.2 Magnet Precautions

- **Never put or store the magnets near credit cards**, televisions, computers, computer disks, microwave ovens, watches, other magnets or items affected by strong magnetic fields. Keep them at least 25 centimeters (10 inches) away.
- **Do not drop the magnets.** They can break and lose magnetic strength if dropped on a hard surface.
- **To avoid cracking or damage to the plastic case**, the magnet should be stored at temperatures ranging from - 20 °C (- 4 °F) to + 55 °C (+ 131 °F)
- **If you lose one of your magnets and need a replacement**, contact your doctor.
- **If you are not sure how to use the magnet or have questions**, ask your doctor to show you how.

### 8.3 How to Handle the VNS Therapy Magnets

Your patient magnet will be given to you after your surgery. You should always carry the magnet with you. You can use the watch-style wrist band or belt clip, or keep the magnet in a pocket or purse. See "Magnet Accessories" on page 18 for more information. Follow all cautions listed above. The magnet can be cleaned with a soft cloth or sponge, and non-abrasive cleaner.

## 8.4 Magnet Accessories

The watch-style accessory attaches the magnet to your wrist with a wristband. The magnet should be on the inside of your wrist so it can be placed over the generator to start or stop stimulation.

The pager-style accessory holds the magnet in a belt clip like a pager. The magnet and clip can be removed without coming apart and placed against the generator to start or stop stimulation.

**Figure 4. Magnet Accessories**

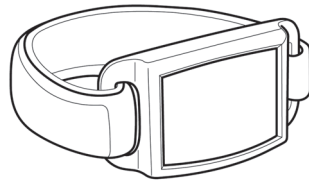

**Watch-Style  
(wristband)**

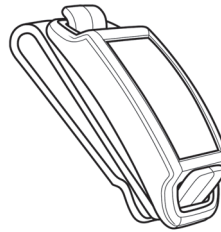

**Pager-Style  
(belt clip)**

## 8.5 How the Magnets Work

The VNS Therapy System senses a magnetic field. When you pass or hold a magnet over the generator, a **reed switch** inside the generator closes. This switch works like a gate. When the magnet closes it, the Normal signal (stimulation) cannot pass. The generator is temporarily turned OFF.

When the magnet is removed, the switch (gate) opens right away. The VNS Therapy System is turned back ON and can stimulate again.

## 8.6 How to Use the Magnet



**In case of a seizure** — The most common use for the magnet is to try to stop a seizure. If you feel an aura or a seizure beginning, start stimulation right away by passing the magnet over the generator for 1-2 seconds. (See details in the sections that follow.)

The Magnet Mode feature is optional. For a few patients, it may not be used. Your doctor will decide whether to use it or turn it OFF. If it is OFF, you will not be able to use the magnet to start stimulation or to check the battery. **You will always be able to stop stimulation (to turn the generator OFF) with the magnet.** If you feel nothing when you pass the magnet over the generator, ask your doctor about increasing the magnet stimulation to a level that you can feel.

**Use the magnet as often as you like, but not longer than 4 hours in a row.** Continuous or frequent magnet use will deplete (use up) the generator battery and could hurt your left vagus nerve. If you need to use the magnet a lot, you may want to have your Normal stimulation settings changed. Discuss this change with your doctor during your next visit.

The magnet may not start stimulation if:

1. The generator is not working. (e.g., the battery has expired).
2. Your doctor has not activated the Magnet Mode feature.
3. The magnet was not used correctly

### 8.6.1 Start Stimulation

Use the magnet to start stimulation when:

- you are having an aura
- a seizure begins
- a seizure is in progress

Pass (move) the magnet over the generator (see Figure 5) for no more than 2 seconds. Stimulation will start immediately after the magnet passes over the generator. If difficulty is encountered with a single pass of the magnet, a cross-pattern swipe technique may also be used.

 The correct position for the magnet may vary from patient to patient. The position depends on how the generator is implanted. Find the position that works best for you.

**Figure 5. Start Stimulation**

#### Standard Magnet Activation

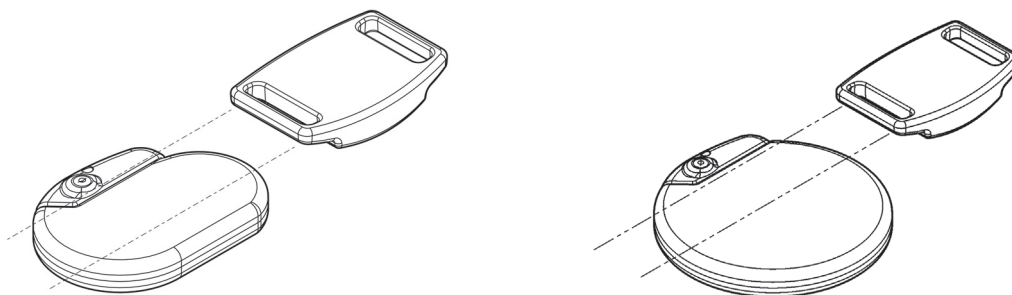

#### Optional Cross-Pattern Magnet Activation

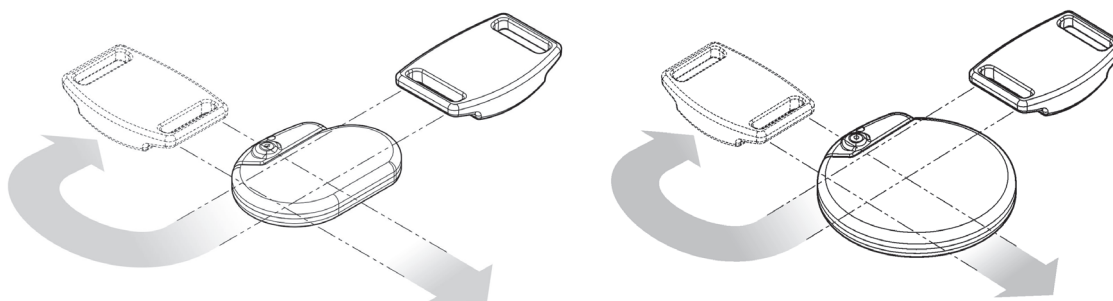

 For Model 103, 104, 105, 106, 1000 and 1000-D generators, the cross-pattern magnet activation technique may cause duplicate magnet activations to be shown in your doctor's records. Your doctor is aware of this and the duplicate magnet activation records are not considered a device malfunction.

## 8.6.2 Stop Stimulation

You may choose to stop stimulation temporarily or turn OFF the generator when:

- you plan to sing or speak in public (if stimulation bothers you when you do this)
- you are eating (if you have swallowing problems)
- stimulation becomes uncomfortable or painful

1. Put the magnet over the generator (see Figure 6). If the stimulation stays on, move the magnet around until it stops.

**Figure 6. Stop Stimulation**

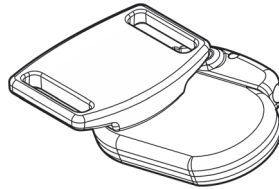

2. Leave the magnet over the generator. If needed, tape it to your chest or use an elastic, wrap-around bandage.
3. If you stopped the stimulation because it was painful or felt unusual, call your doctor right away.

**With your doctor's permission, it is okay to leave the magnet in place** for a short while, for example, to sing a song. The generator will not stimulate while the magnet is in place. The Normal Mode cycle begins again when the magnet is removed.

*The generator will not stimulate while the magnet is in place, but it will start when the magnet is removed.*



**Note:** After the magnet is removed, Normal Mode stimulation will start again with an OFF time.



**Note:** If the magnet is used to stop stimulation for less than 65 seconds, you may receive a single Magnet Mode stimulation when you remove the magnet.

## 8.6.3 Check the Generator Battery

*The steps used to check the battery are the same as the steps used to start stimulation (see "Start Stimulation" on page 19).*



If Magnet Mode is turned on, use the magnet each day to check that the generator is working.

## 8.7 How to Replace the VNS Therapy Magnets

To order a new magnet, contact your doctor.

## 9 Device Complications

Complications linked to the VNS Therapy System can result from:

- Surgery
- Generator malfunction (not working)
- Battery depletion (running out)
- Touching or moving the device through the skin

### 9.1 Surgery

All types of surgery carry some risks. In addition to the risks described in “Clinical Study Participants” section on page 22, there are potential mechanical complications related to the surgical implantation of the device. The generator and/or lead can—but rarely do—move or come through the skin. Also, the lead can break or become disconnected from the generator.

### 9.2 Generator Malfunction (Device Not Working Right)

The generator can malfunction, though this is rare. The stimulation from a generator that is not working right can cause intense neck pain, hoarseness, choking, or trouble breathing.



**Stimulation from a generator that is not working right could damage the vagus nerve** and lead to permanent hoarseness or other complications. Malfunction of the generator could cause the battery to run out sooner than expected. **If you have any of these symptoms**, or if stimulation becomes painful, irregular, or nonstop, place the magnet over the generator. Hold it there to stop stimulation (see “How to Use the Magnet” on page 18), then **call your doctor right away**.

### 9.3 Battery Depletion (Running Out)

The battery in the generator can last from 1 to 16 years. The lifespan depends on these factors:

- Generator model
- Stimulation settings your doctor chooses
- Interaction of the lead and vagus nerve over time

The generator battery will slowly lose its power. When it starts to run out, it will begin to stimulate differently. You may sense this change as irregular stimulation. At the end of battery life, the stimulation will stop completely.

The dose settings impact how long the battery in the generator will last. For example, the battery may last for 3 years at a higher setting, compared with 8 years at a lower setting. For the full range of settings in relationship to battery life, ask your doctor.

When the battery in your generator runs out, the generator must be replaced in order for you to continue to receive VNS Therapy. This requires an additional surgical procedure. The operation involves anesthesia and generally takes less than an hour to complete.

Replacement or removal of the lead is a different procedure. It is not required for routine replacement of the generator.



**After stimulation stops completely** (when the generator battery runs out), seizure rate, intensity, or duration may increase. If Normal stimulation stops, your seizures may become worse than before stimulation started. If you think the generator might not be working right, call your doctor.

## 9.4 Manipulation of the Generator and Lead

The generator is secured into place during surgery, but the device can move slightly. It may be possible to feel the lead under the skin after surgery. This feeling is normal and should become less obvious over several weeks. Manipulation of the lead should be prevented at all times.



Never move or twist the generator or manipulate the lead. Doing so could damage the lead or your vagus nerve. It could require that the generator and lead be replaced.

## 10 **Patient Registration and Safety Listing**

Government agencies require makers of implantable devices to contact people in case of emergencies related to the device. LivaNova has a list of people who have had the generator and lead implanted. The information is kept in confidential files. It is a permanent record of the implantation surgery. In some cases, the file has information on seizures. LivaNova will release a file only if required by law.



Please send LivaNova **a change of address notice** if you move.



## 11 **Frequently Asked Questions**

Patients and their family members often ask these questions.

### ***How do most people respond to VNS Therapy?***

When the device was tested in the clinical trials, the seizure rate decreased for most patients. Some patients had no change or had an increase in seizure rate. Some patients do not have a clear decrease in seizure rate until after they have had many months of VNS Therapy.

### ***Can I know if I will be helped before I am implanted with the generator and lead?***

At this time, there is no way to predict what your response will be.

### ***What are the results of the VNS Therapy clinical trials?***

This manual provides a summary of important safety and effectiveness results from the clinical studies. Your doctor can give you information about the clinical (research) studies.

### ***What are the side effects of VNS Therapy?***

The most common side effects reported for the VNS Therapy System are a tingling sensation in the neck and mild hoarseness in the voice, both of which occur only during stimulation. See "Side Effects" on page 31 for information about less common side effects.

### ***Are the generator and lead materials safe for my body?***

Yes, all generator and lead materials that touch your body are safe. Examples of these materials include titanium, stainless steel, polyurethane, and silicone. These materials have a long history of being safely used in medical devices. Detailed information is in the physician's manual, so ask your doctor if you have more questions.

### ***What is the implantation surgery like?***

You will be given a general or local anesthetic. The operation usually takes 1 to 2 hours. You will probably stay in the hospital overnight. Ask your surgeon to tell you more about the anesthetic, the operation, and the hospital stay so that you will know what to expect.

### ***Are there risks linked with the surgery?***

Any surgery has some type of risk. It is important that you discuss this question with your surgeon.

### ***What is the size of the generator and the lead?***

The size of the generator depends on the model. It is shaped like a disk and is up to approximately 2 inches (5cm) in diameter. The lead is a thin flexible tube 17 inches long (43 cm). Detailed dimensions are in the physician's manual, so ask your doctor if you have more questions.

### ***Will the scars be noticeable?***

Each person has different healing and scarring results. You should expect some scarring from surgery. Most people do not think the scarring after surgery is a major concern. If this is a special concern for you, discuss it with your surgeon.

***Will people be able to see the implanted device through my skin?***

The lead is attached to the vagus nerve and not visible. The generator is shaped like a disk and is up to approximately 2 inches (5 cm) in diameter, depending on the model. If you have a small frame or are very thin, the device may be visible below your left collarbone. Talk to your doctor if you have concerns.

***What happens after the surgery?***

Your doctor will program your treatment settings into your device. If the stimulation feels uncomfortable, your doctor can change it to make you more comfortable. The doctor will use the programming wand to check and fine-tune your stimulation settings at each visit.

Your generator will work automatically, but you can use the magnet to start or stop stimulation at any time. Your doctor will show you how and when to use it.

***How long will my implanted lead last?***

The lead lifespan varies with each person. A lead would need to be replaced if it is broken. Do not pick, twist, or hit at the areas where the generator and lead are implanted. This helps to avoid damage to the lead.

***Will I be able to tell when the stimulator is on?***

Many people note a tingling feeling or a change in their voice (hoarseness) during stimulation. This effect usually becomes less noticeable over time.

***What does the magnet do?***

The magnet is used to start and stop stimulation. Your doctor must activate the Magnet Mode before you can start stimulation with the magnet.

***Can I stop all my seizures with the magnet?***

Results from magnet stimulation differ for each person. Some people report that the magnet stops all or most of their seizures, lessens the intensity, or shortens the duration. For others, the magnet has limited or no effect.

***When should I use the magnet?***

Use the magnet in these three circumstances:

1. To start stimulation when you are having an aura that comes before a seizure, you think a seizure is starting or any time during a seizure
2. To stop stimulation
3. To test that the device is operating properly

***Is it possible to stop all stimulation using the magnet?***

Yes. To stop stimulation, hold the magnet over the generator and keep it there. Use this method if you have unusual or painful stimulation, and call your doctor right away. The magnet will stop all stimulation while it is held in place. You may need to secure the magnet by taping it over the device.

***What if the magnet is accidentally kept in place over the generator for an extended period?***

No stimulation will be delivered while the magnet is kept over the device. Normal and magnet-started stimulations will resume only after the magnet is removed.

***How often can I use the magnet?***

Use the magnet as often as you like, but for no more than 4 hours (1 stimulation right after another). Constant or frequent use of the magnet will use up the battery in the generator and could hurt the nerve. If you use the magnet often, your normal device settings may need to be changed. Discuss this fact with your doctor during your next visit.

Depending on the settings, the magnet starts the device for 7 to 60 seconds each time you use it. Using it again during the same period has no effect on output amplitude, but will restart the magnet ON time. Wait until the stimulation ends before trying it again.

***Will the magnet affect my normal treatment schedule?***

The magnet overrides your normal treatment schedule, whether or not the device is "ON" at that time. Once the magnet-activated stimulation ends, the device will return to the treatment schedule set by your doctor.

***Do I have to use the magnet to try and stop a seizure?***

No. Whether you use the magnet or not is completely up to you and whoever is with you. It may also depend somewhat on whether the magnet has helped before.

***How does the magnet work?***

The generator has a sensor (the reed switch) that recognizes the magnet and starts extra stimulation.

***Can any magnet be used?***

Only the VNS Therapy magnet should be used with your VNS Therapy System. If you lose your magnet or need extra magnets, contact your doctor. In an emergency, you may try other strong magnets. The use of other, magnets, not supplied by your doctor, will not harm the VNS Therapy System, but there is no way to know whether a magnet other than the VNS Therapy magnet will work.

***Who should carry the magnet?***

You should carry the magnet with you at all times. You may also want your family members or caregivers to carry a VNS Therapy magnet, so they can apply it if they see you having a seizure.

***Is the magnet an environmental hazard?***

The VNS Therapy magnet can damage computer disks, credit cards, watches, and other items affected by strong magnetic fields. Keep your magnet at least 25 centimeters (10 inches) away from any of these items. Do not store magnets near such items.

***Will dropping my magnet affect its strength?***

Dropping your magnet should not affect the magnet's strength. This is a common problem with low-power magnets. The VNS Therapy magnet is a high-power magnet and should not lose its strength when dropped or if the casing cracks.

***How long will my magnet last (does it have an expiration date)?***

Based on normal use, the VNS Therapy magnet should have an approximate service life of 3 years.

***Will all of my seizures be detected if I have the Model 106 or 1000/1000-D generator?***

It depends. Several factors determine how accurately the generator can detect seizures, and results can vary from patient to patient. Discuss questions regarding the AutoStim feature with your doctor who is the most knowledgeable about your medical condition and history.

***If I have the Model 106 or 1000/1000-D generator and Automatic Stimulation is activated, does that mean I'm about to have a seizure?***

Not in all cases. The Automatic Stimulation is designed to trigger based on changes in your heart rate, which may signal the start of a seizure. Depending on settings programmed by your doctor and your medical condition, an Automatic Stimulation may or may not be correlated with an actual seizure. It is important for you to tell your doctor if you think stimulation is coming on too much or too little so your doctor can adjust the settings appropriately.

***Questions?***

If you have other questions about the VNS Therapy System, any of its parts, or VNS Therapy in general, talk to your doctor.

## 12 Glossary

**adjunctive therapy**

Additional, add-on; VNS is adjunctive therapy, which is added on to other antiepileptic treatments

**aspiration**

Accidental sucking in of food particles or fluids into the lungs

**clinical studies**

Tests of the effectiveness and safety of a therapy on humans

**diathermy**

Diathermy is a treatment to promote healing or relieve pain

**dysautonomia**

A term used to describe several different medical conditions that cause a malfunction of the Autonomic Nervous System, which controls the “automatic” functions of the body that we don’t consciously think about (e.g., heart rate, blood pressure, digestion, dilation, and pupil constriction, kidney function and temperature control)

**electrodes**

Part of the VNS Therapy lead that connects to the vagus nerve

**epilepsy**

Disorder with seizures

**generator**

VNS Therapy device implanted in the patient’s chest; holds the battery and delivers stimulation to the vagus nerve through the VNS Therapy lead

**lead**

VNS Therapy lead; small wire that connects the VNS Therapy generator to the vagus nerve

**LivaNova**

Company that makes the VNS Therapy System

**MR**

Magnetic resonance

**MR Conditional**

An item that has been demonstrated to pose no known hazards in a specified MR environment with specified conditions of use

**MR Unsafe**

An item that poses hazards in all MRI environments

**MRI**

Magnetic resonance imaging

**postictal**

Recovery period after a seizure

**programming wand**

VNS Therapy instrument used to check or change VNS Therapy device and settings

**reed switch**

A mechanism that works like a gate. When the magnet closes it, the Normal signal (stimulation) cannot pass; the generator is temporarily turned OFF

**seizure**

Convulsion; epileptic attack; a symptom of people with epilepsy

**stimulate**

Send electrical signal; with VNS Therapy, the generator sends an electrical signal through the lead to the vagus nerve, which carries the signal to the brain

**stimulation**

The electrical signal that is sent from the generator to the brain

**vagus nerve**

A nerve that extends from the brain through the neck to the major organs (e.g., heart, lungs, and stomach) in the torso

**vagus nerve stimulation (VNS)**

The electrical signal sent from the generator to the vagus nerve

**VNS Therapy®**

Treatment received from vagus nerve stimulation

**VNS Therapy System**

All of the parts that provide VNS Therapy: generator, lead, programming wand, programming computer, programming software, and magnets

## 13 Contact Information



**Manufacturer**

**LivaNova USA, Inc.**

100 Cyberonics Boulevard  
Houston, Texas 77058  
USA



**Authorized Representative**

**LivaNova Belgium NV**

Ikaroslaan 83  
B-1930 Zaventem  
BELGIUM

**Internet**

[www.livanova.com](http://www.livanova.com)

Report all adverse events related to your device to your doctor and to your local regulatory authority:

Australia - <https://www.tga.gov.au/>

Canada - <https://www.canada.ca/en/health-canada.html>

UK - <https://www.gov.uk/government/organisations/medicines-and-healthcare-products-regulatory-agency>

EU - [https://ec.europa.eu/growth/sectors/medical-devices/contacts\\_en](https://ec.europa.eu/growth/sectors/medical-devices/contacts_en)

## 14 Clinical Study Participants

Safety and effectiveness studies of VNS Therapy involved more than 450 people (both men and women). Most of these people had uncontrolled partial onset seizures. Most had more than six seizures a month, but all had at least one seizure a month in spite of taking drugs for epilepsy. The typical person in the study was about 33 years old (ages ranged from 3 to 63). He or she had epilepsy for more than 20 years before trying VNS Therapy.

Most took two drugs for seizures while they received VNS Therapy.

Some of them have now received VNS Therapy for more than 10 years. Worldwide, more than 40,000 people have had the VNS Therapy System implanted. If you would like to learn more about these research studies, talk to your doctor.

### 14.1 Side Effects

Some side effects are linked with the VNS Therapy System and stimulation. As a rule, they become less noticeable over time for most patients. Other problems, such as trouble breathing, can occur if device settings are set too high at first or are increased too rapidly, or if the device is started too soon after surgery. If this happens, your doctor can change the device settings.

The VNS Therapy System is not a drug. It does not cause drug-related toxic central nervous system side effects. Examples of such effects are memory loss, confusion, drowsiness (sedation), and difficulty concentrating.

#### 14.1.1 Common Side Effects

The most common side effect is hoarseness. Three other common side effects are sore throat, shortness of breath, and coughing. As a rule, these problems typically occur only during stimulation (the ON time of the cycle). Mostly, it lasts about 30 seconds every 5 minutes. Most people who have hoarseness, as well as the other three side effects, tolerate it well and notice it less as time goes on.



Call your doctor any time hoarseness is painful, constant, or persists.



Testing magnet settings while you are in the doctor's office will help make sure you **can tolerate the settings**. Stimulation—or stopping it—can make seizures worse.

The following is a partial alphabetical list of the side effects possibly associated with the VNS Therapy System and reported during clinical trials of the VNS Therapy System. You may experience one or more of them. Talk to your doctor if any one of these items becomes too uncomfortable.

- Lack of coordination in the voluntary muscles (ataxia)
- Difficulty breathing, shortness of breath (dyspnea)
- Hoarseness (voice alteration)
- Impaired sense of touch (hypesthesia)
- Inability to sleep (insomnia)
- Increased coughing
- Indigestion (dyspepsia)



- Infection
- Inflammation of the throat (pharyngitis)
- Muscle movements or twitching generally associated with stimulation
- Nausea
- Pain
- Prickling of the skin (paresthesia)
- Throat, larynx spasms (laryngismus)
- Vomiting

These side effects could *potentially* occur:

- Aspiration (fluid in the lungs)
- Blood clotting
- Choking sensation
- Damage to nerves or blood vessels in the surgical area, including the carotid artery and jugular vein
- Device (generator and/or lead) migration or extrusion
- Difficulty swallowing (dysphagia)
- Dizziness
- Duodenal ulcer, gastric ulcer
- Ear pain
- Facial flushing (may be more likely in children aged 4-11 years)
- Facial paralysis, paresis
- Foreign body reaction to implants, including possible tumor formation
- Formation of fibrous tissue, pockets of fluid
- Heart rate and rhythm changes
- Hiccups
- Incision site pain
- Irritability
- Left hemidiaphragm paralysis
- Left vocal cord injury or paralysis (affects voice)
- Low-grade fever
- Muscle pain
- Neck pain
- Nerve injury

- Painful or irregular stimulation
- Ringing in the ears (tinnitus)
- Skin, tissue reaction
- Sore, painful throat (laryngeal irritation)
- Stomach discomfort
- Tooth pain
- Unusual scarring at the incision site
- Urinary retention
- Vagus nerve paralysis
- Weight change/Loss of appetite (potential for increased risk in children and adolescents)
- Worsening of asthma and bronchitis
- Worsening of cardiac abnormalities, including heart rate and rhythm

### 14.1.2 Surgical Complications

These surgical complications are sometimes linked with the VNS Therapy System. They may be short-term or long-term.

- Infection
- Pain at the incision site
- Tissue reactions, (responses of the skin) such as inflammation (redness) and skin irritation (soreness, itchiness)
- Blood clotting
- Pockets of fluid or fibrous tissue around the implanted devices
- Damage to or paralysis (loss of movement) of nearby nerves or muscles
- Hoarseness
- Changes or abnormalities in heart rate or function



Implantation of the lead may cause nerve constriction (squeezing of the nerve). **Call your doctor right away** if your voice is always hoarse a few days after surgery. (There could be other explanations for this symptom.)



If you undergo VNS generator replacement with a larger size device, you may initially experience increased discomfort or inflammation at the surgery site. Call your doctor if you experience symptoms that are concerning or do not improve.

### 14.1.3 Surgical Scars

Scars from the surgery can be lessened. Talk to your surgeon if you have specific concerns.

## 14.2 Sudden Unexpected Death in Epilepsy (SUDEP)



**Sudden unexpected death in epilepsy (SUDEP):** Through August 1996, 10 sudden and unexpected deaths (definite, probable, and possible) were recorded among the 1,000 patients implanted and treated with the VNS Therapy device. During this period, these patients had accumulated 2,017 patient-years of exposure.

Some of these deaths could represent seizure-related deaths in which the seizure was not observed, at night, for example. This number represents an incidence of 5.0 definite, probable, and possible SUDEP deaths per 1,000 patient-years.

An update was performed with U.S. patient data through February 2005. This data includes 31,920 tracked VNS patients with 81,918 patient-years of implant experience. The total death count during this period was 733, indicating an all-cause mortality rate of 8.9 deaths per 1,000 patient-years. Of these 733 deaths, 387 were found to be “definitely not SUDEP”, 112 to be “possible SUDEP” and 234 to be unclassifiable for lack of information. If combined, these last two categories indicate the highest possible SUDEP rate to be 4.2 per 1,000 patient-years, which is marginally less than previously observed.

Although this rate exceeds that expected in a healthy (nonepileptic) population matched for age and sex, it is within the range of estimates for epilepsy patients not receiving vagus nerve stimulation, ranging from 1.3 SUDEP deaths for the general population of patients with epilepsy, to 3.5 (for definite and probable) for a recently studied antiepileptic drug (AED) clinical trial population similar to the VNS Therapy System clinical cohort, to 9.3 for patients with medically intractable epilepsy who were epilepsy surgery candidates.